

# Service Manual Trucks

Group **37**

Electrical Schematic:  
Heated Mirrors

VN

From Build Date 8.99

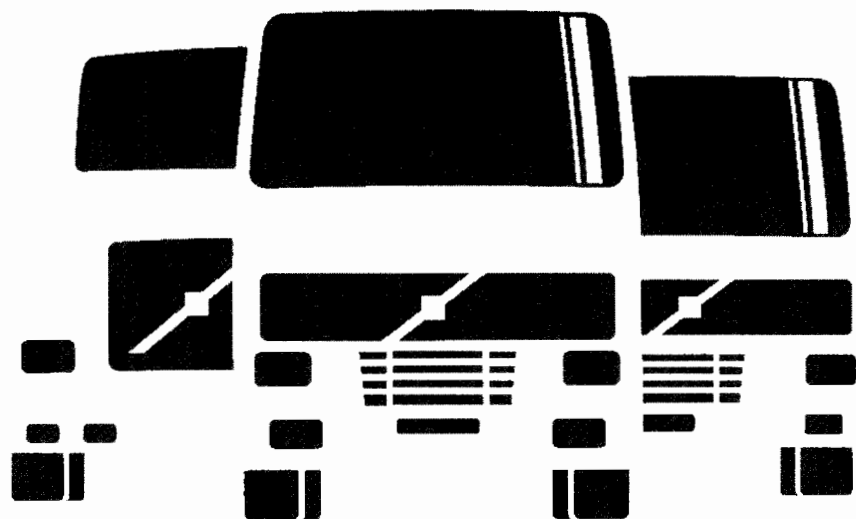

BATTERY 12 VOLT  
 IGNITION 12 VOLT  
 ACCESSORY 12 VOLT

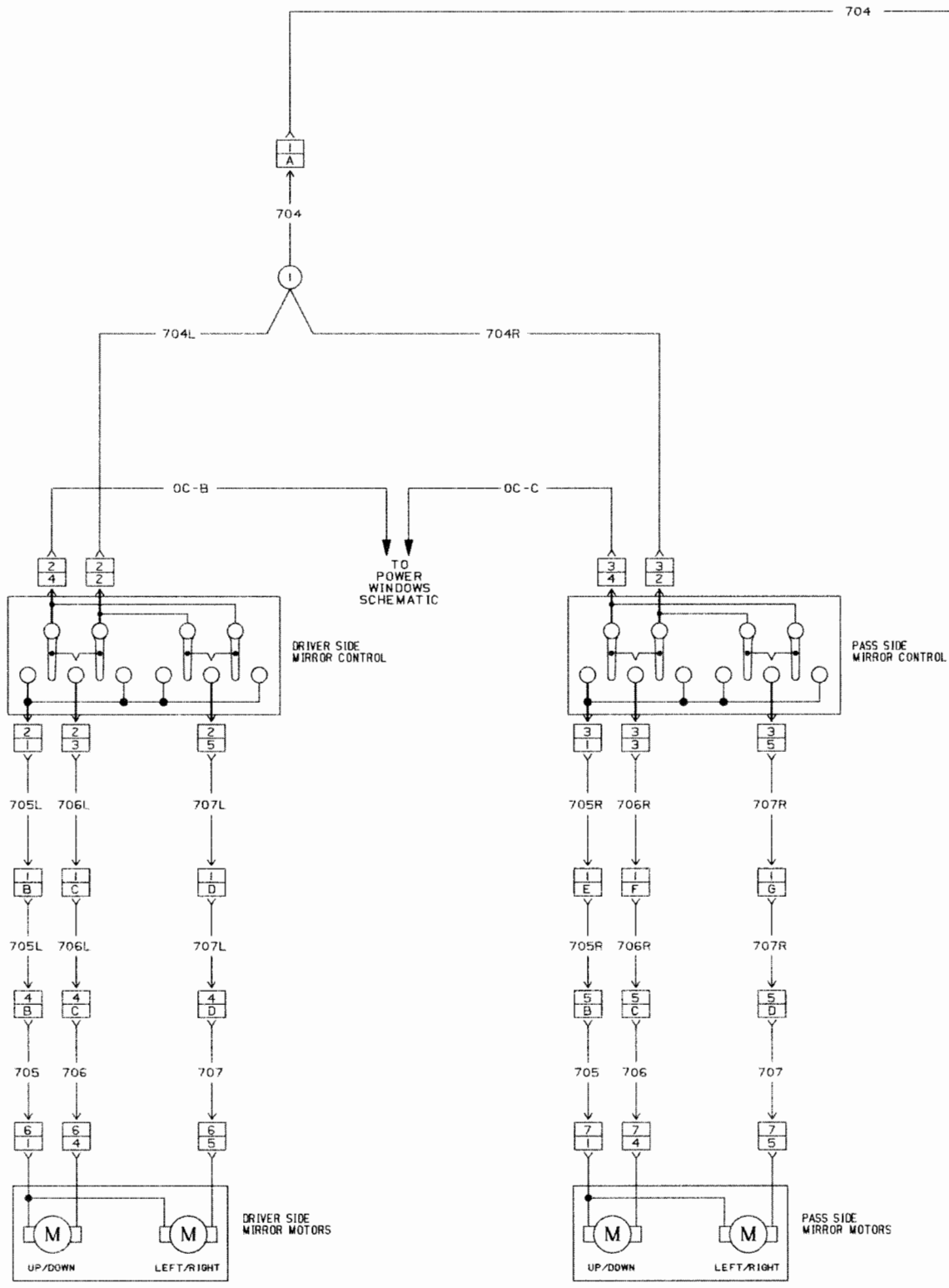

TO DIAGNOSIS SCHEMATIC  
 TO HAZARD SIGNAL SCHEMATIC  
 TO BACK CAB LIGHT SCHEMATIC  
 TO MARKER SCHEMATIC  
 TO ABS CONTR SCHEMATIC

GROUND

# Heated Mirrors - VN

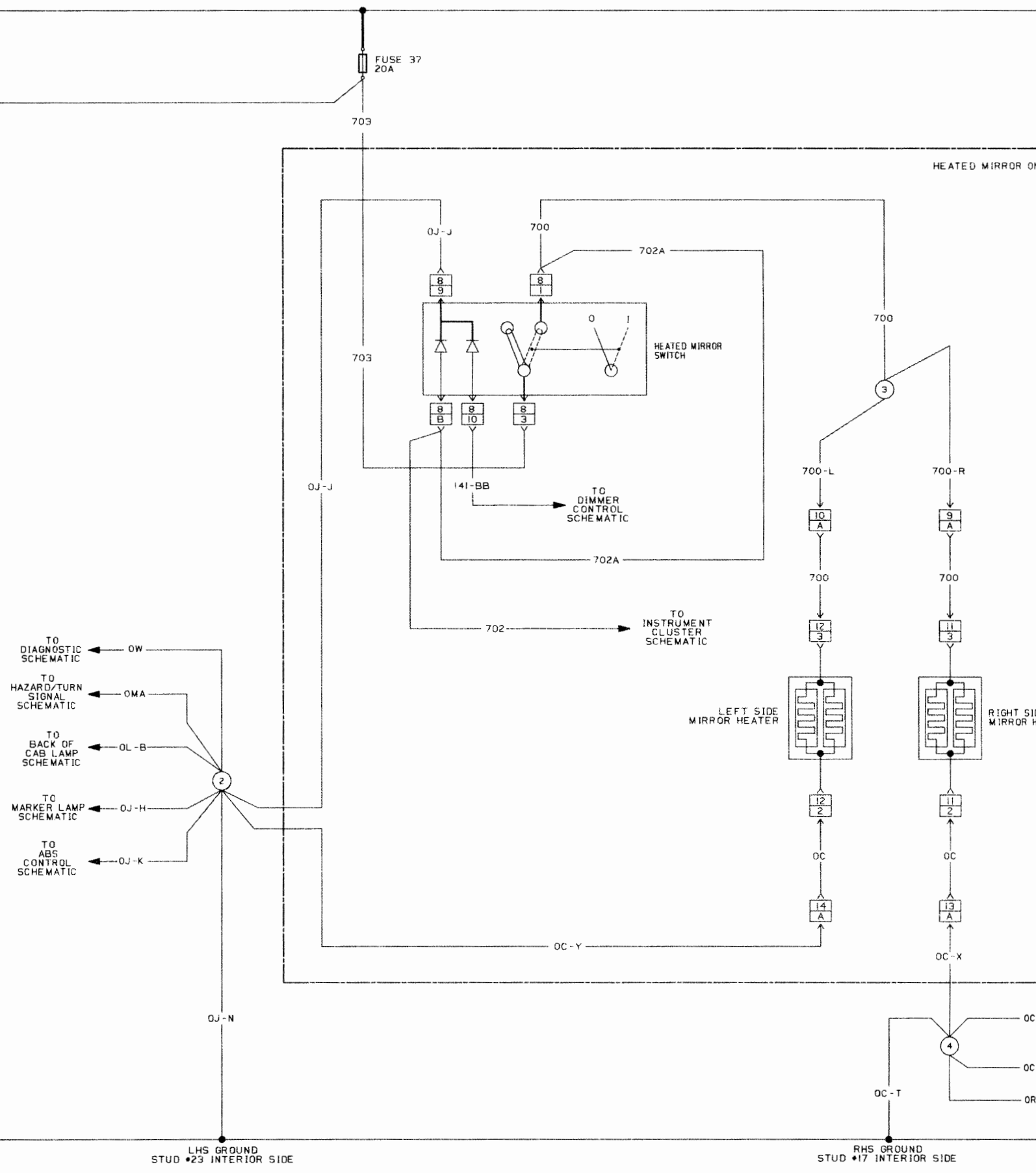

**CONNECTOR AND SPLICE INFORMATION  
CONNECTORS VIEWED FROM CABLE ENTRY**

| EFFECTIVE DATE | DESCI |
|----------------|-------|
|                |       |
|                |       |
|                |       |
|                |       |
|                |       |
|                |       |
|                |       |
|                |       |
|                |       |

**CONNECTOR 1  
MAIN CAB TO DOOR HARNESS**

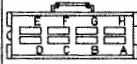

| TABLE OF CONTENTS |         |                 |
|-------------------|---------|-----------------|
| CAVITY            | CIRCUIT | FUNCTION        |
| A                 | 704     | 12 VOLT SUPPLY  |
| B                 | 705L    | MOTOR COM. FEED |
| C                 | 706L    | UP OR DOWN      |
| D                 | 707L    | LEFT OR RIGHT   |
| E                 | 705R    | MOTOR COM. FEED |
| F                 | 706R    | UP OR DOWN      |
| G                 | 707R    | LEFT OR RIGHT   |

**CONNECTOR 2  
LEFT HAND SIDE MIRROR CONTROL**



| TABLE OF CONTENTS |         |                 |
|-------------------|---------|-----------------|
| CAVITY            | CIRCUIT | FUNCTION        |
| 1                 | 705L    | MOTOR COM. FEED |
| 2                 | 704L    | 12 VOLT SUPPLY  |
| 3                 | 706L    | UP OR DOWN      |
| 4                 | 0C-B    | GROUND          |
| 5                 | 707L    | LEFT OR RIGHT   |

**CONNECTOR 3  
RIGHT HAND SIDE MIRROR CONTROL**



| TABLE OF CONTENTS |         |                 |
|-------------------|---------|-----------------|
| CAVITY            | CIRCUIT | FUNCTION        |
| 1                 | 705R    | MOTOR COM. FEED |
| 2                 | 704R    | 12 VOLT SUPPLY  |
| 3                 | 706R    | UP OR DOWN      |
| 4                 | 0C-C    | GROUND          |
| 5                 | 707R    | LEFT OR RIGHT   |

**CONNECTOR 4  
MAIN CAB TO LEFT HAND MIRROR HARNESS**



| TABLE OF CONTENTS |         |                 |
|-------------------|---------|-----------------|
| CAVITY            | CIRCUIT | FUNCTION        |
| B                 | 705L    | MOTOR COM. FEED |
| C                 | 706L    | UP OR DOWN      |
| D                 | 707L    | LEFT OR RIGHT   |

**CONNECTOR 5  
MAIN CAB TO RIGHT HAND MIRROR HARNESS**



| TABLE OF CONTENTS |         |                 |
|-------------------|---------|-----------------|
| CAVITY            | CIRCUIT | FUNCTION        |
| B                 | 705R    | MOTOR COM. FEED |
| C                 | 706R    | UP OR DOWN      |
| D                 | 707R    | LEFT OR RIGHT   |

**CONNECTOR 6  
LEFT HAND SIDE MIRROR MOTORS**

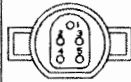

| TABLE OF CONTENTS |         |                 |
|-------------------|---------|-----------------|
| CAVITY            | CIRCUIT | FUNCTION        |
| 1                 | 705     | MOTOR COM. FEED |
| 4                 | 706     | UP OR DOWN      |
| 5                 | 707     | LEFT OR RIGHT   |

**CONNECTOR 7  
RIGHT HAND SIDE MIRROR MOTORS**

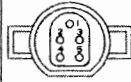

| TABLE OF CONTENTS |         |                 |
|-------------------|---------|-----------------|
| CAVITY            | CIRCUIT | FUNCTION        |
| 1                 | 705     | MOTOR COM. FEED |
| 4                 | 706     | UP OR DOWN      |
| 5                 | 707     | LEFT OR RIGHT   |

**CONNECTOR 8  
HEATED MIRROR SWITCH**



| TABLE OF CONTENTS |          |                         |
|-------------------|----------|-------------------------|
| CAVITY            | CIRCUIT  | FUNCTION                |
| 1                 | 700/702A | 12 VOLT TO HEATERS      |
| 9                 | 0J-1     | GROUND                  |
| B                 | 702A     | SWITCH LAMP SUPPLY      |
| 702               |          | HEATED MIRROR LAMP FEED |
| 10                | 141-BB   | ILLUMINATION            |
| 3                 | 703      | 12 VOLT SUPPLY          |

**CONNECTOR 9  
MAIN CAB TO RIGHT HAND MIRROR HARNESS**



| TABLE OF CONTENTS |         |                |
|-------------------|---------|----------------|
| CAVITY            | CIRCUIT | FUNCTION       |
| A                 | 700-R   | 12 VOLT SUPPLY |

**CONNECTOR 10  
MAIN CAB TO LEFT HAND MIRROR HARNESS**



| TABLE OF CONTENTS |         |                |
|-------------------|---------|----------------|
| CAVITY            | CIRCUIT | FUNCTION       |
| A                 | 700-L   | 12 VOLT SUPPLY |

**CONNECTOR 11  
RIGHT HAND SIDE MIRROR CONNECTION**

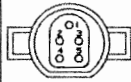

| TABLE OF CONTENTS |         |                |
|-------------------|---------|----------------|
| CAVITY            | CIRCUIT | FUNCTION       |
| 3                 | 700     | 12 VOLT SUPPLY |
| 2                 | 0C      | 0 VOLT SUPPLY  |

**CONNECTOR 12  
LEFT HAND SIDE MIRROR CONNECTION**

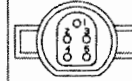

| TABLE OF CONTENTS |         |                |
|-------------------|---------|----------------|
| CAVITY            | CIRCUIT | FUNCTION       |
| 3                 | 700     | 12 VOLT SUPPLY |
| 2                 | 0C      | GROUND         |

**CONNECTOR 13  
MAIN CAB TO RIGHT HAND MIRROR GROUND CONNECTION**



| TABLE OF CONTENTS |         |          |
|-------------------|---------|----------|
| CAVITY            | CIRCUIT | FUNCTION |
| A                 | 0C      | GROUND   |

**CONNECTOR 14  
MAIN CAB TO LEFT HAND MIRROR GROUND CONNECTION**



| TABLE OF CONTENTS |         |          |
|-------------------|---------|----------|
| CAVITY            | CIRCUIT | FUNCTION |
| A                 | 0C      | GROUND   |

| SPLICE LOCATION CHART |             |                                   |
|-----------------------|-------------|-----------------------------------|
| SPLICE                | HARNESS     | LOCATION                          |
| 1                     | DRIVER DOOR | 175MM FROM MIRROR SWITCH          |
| 2                     | CAB         | 100MM FROM ENGINE HARN. BREAKOUT  |
| 3                     | CAB         | 50MM FROM SRS BREAKOUT            |
| 4                     | CAB         | 210MM FROM CHASSIS HARN. BREAKOUT |

**SYMBOL DEFINITION**

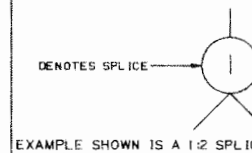

**SYMBOL DEFINITION**

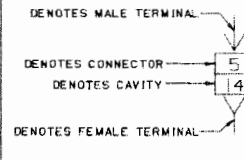

ED MIRROR ONLY

RIGHT SIDE  
MIRROR HEATER

OC - J → TO  
POWER SEAT  
SCHEMATIC

OC - 7 → TO  
HAZARD/TURN  
SIGNAL  
SCHEMATIC

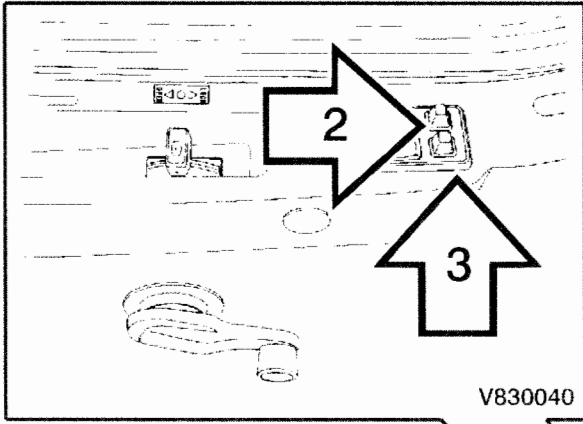

V830040

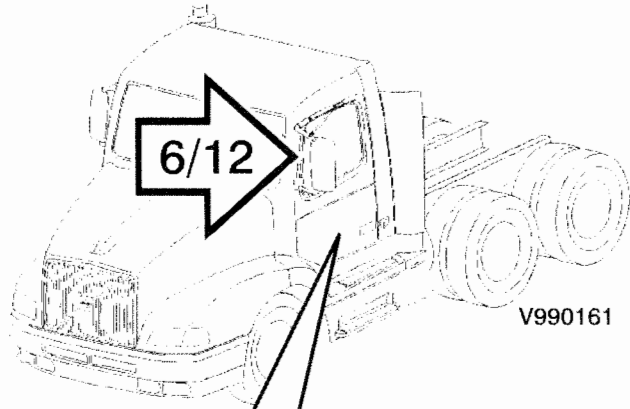

V990161

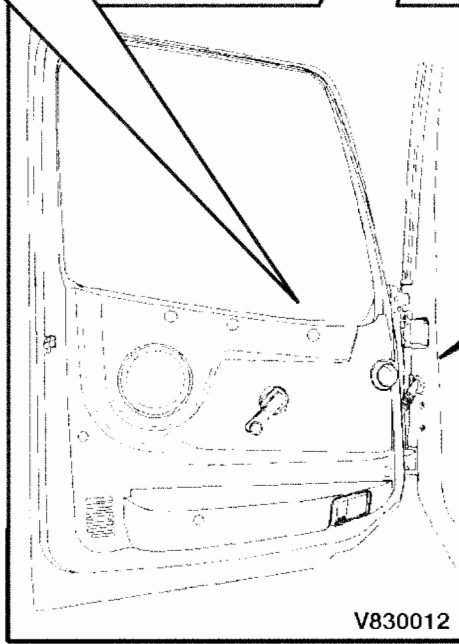

V830012

